

Data Sheet



Article number: 0108042

Description: Retaining ring JK 25 DIN 984

Measures

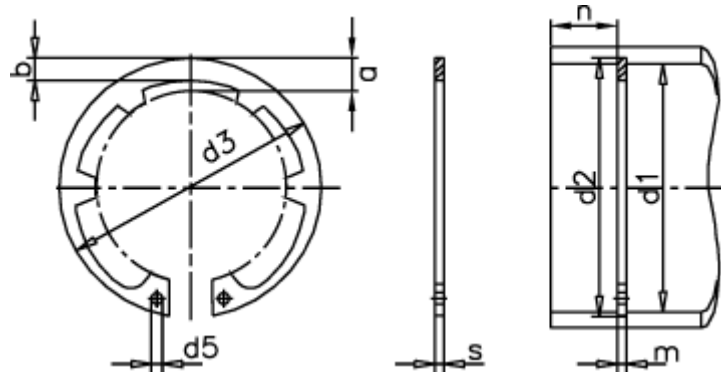

a max	= 4.4	FN kN	= 8.0	s	= 1.20
AN mm ²	= 48.2	FRg kN	= 4.7	t	= 0.60
b	= 2.8	FR kN	= 14.6	tol	= +0,21
d1	= 25	g	= 1.0	tol	= -0.06
d2	= 26.2	K kN-mm	= 29.0	tol	= +0,42-0,21
d3	= 26.9	m min	= 1.30	Tong	= ZGJ-2
d5 min	= 2.0	Nominal drive	= 1.8	Weight kg/1000	= 1.72
Description	= JK 25	Number of serrations	= 6		